

FLAPS V6 HBLC

(left-hand design with rotary switch in the panel's center and 4 LED indicators,
4 control positions)



FLAPS V6 HBLC 3P

(left-hand design with rotary switch in the panel's center and 4 LED indicators,
3 control positions)



Page intentionally left blank

Table of contents

1 Important notes and warnings.....	5
2 Product description.....	6
2.1 Product use.....	6
2.2 Main product functionalities.....	6
2.3 Inputs.....	6
2.4 Controls.....	7
2.5 Outputs.....	7
2.6 Indication.....	7
2.7 Protections.....	7
2.8 Description of the control panel.....	8
2.8.1 Control panel HBR (4 control positions).....	8
2.8.2 Control panel HBR 3P (3 control positions).....	9
2.8.3 Control panel HBLC (4 control positions).....	10
2.8.4 Control panel HBLC 3P (3 control positions).....	11
2.8.5 Differences between HBR, HBR 3P, HBLC, HBLC 3P variants and how to read this manual when using the HBR 3P variant.....	12
3 Specifications.....	13
3.1 Electrical characteristics.....	13
3.2 Mechanical specifications.....	13
3.3 Allowed operating conditions.....	13
3.4 Lifetime and warranty.....	14
3.5 Tests according to DO-160G.....	15
4 Installation in an airplane.....	16
4.1 Mechanical installation.....	16
4.2 Position sensor mounting.....	17
4.3 Actuator installation.....	17
4.4 Electrical connections.....	19
4.4.1 Electrical connections of actuator with internal position sensor and limit switches.....	20
4.4.2 Electrical connections with simple actuator, external position sensor and limit switches.....	21
4.4.3 Electrical connections for dimming control unit display elements.....	22
5 Description of functions.....	23
5.1 Normal mode – automatic.....	23
5.2 Errors and faults.....	24
5.3 Safety mode – manual.....	25
5.4 Device setup mode.....	26

5.5 Position programming mode.....	28
5.6 Landing gear control output.....	30
5.7 Dimming of indicator elements.....	30
6 Errors and faults, troubleshooting.....	31
6.1 Indicated errors and faults.....	31
6.2 Troubleshooting.....	35

1 Important notes and warnings

Thank you for purchasing FLAPS V6 HBLC (3P). For a comfortable and safe use of this product, please pay attention to THE ENTIRE MANUAL, especially the notes and warnings below.

- Although the FLAPS V6 HBLC (3P) control unit has been thoroughly tested to ensure maximum safety in all conceivable situations, THE RIGHT FUNCTIONALITY DEPENDS ON THE RIGHT INSTALLATION AND SETTINGS.
- Therefore, it is **NECESSARY to READ CAREFULLY and UNDERSTAND THIS MANUAL COMPLETELY.**
- Keep this manual printed in an airplane for cases of emergency or change of ownership.
- THIS PRODUCT IS NOT APPROVED FOR INSTALLING IN CERTIFIED AIRPLANES.
- The pilot MUST UNDERSTAND the control of this product before the first flight. DO NOT use the product unless you are sure how it works!
- Do not allow unauthorized persons to handle the installed product.
- After installing the product, before the first flight, turn on ALL possible sources of electromagnetic interference on board the aircraft and ensure that the instrument is functioning properly.
- Use of the device in conflict with this manual, with bad wiring, outside the allowed operating conditions, etc., may cause the device to malfunction or damage and endanger flight safety.
- If the product repeatedly indicates an error, do not use it and turn off the power! (except for switching to safety manual mode in the event of a position sensor error where the position of the flaps can be manually controlled)
- AVOID contact with liquids and chemicals
- Before installation, check the mechanical integrity of the device and its accessories
- DO NOT disassemble the device!
- After installation, carefully check the functionality of the device and its installation
- The responsibility for the installation is entirely with the installer.
- Responsibility for performed control actions is fully with the operator (pilot).
- If you do not agree to the notes and warnings above, do not use this product.

Company LAMBERT AERODEVICES s.r.o. reserves the right to change, improve the product or manual without prior or subsequent notice.

2 Product description

2.1 Product use

Product FLAPS V6 is designed for electric control of flaps of UL aircraft. It is usually supplied as a set: electronic control unit + servo motor (in case of motor without internal sensor: + position sensor + 2x protective limit switch).

THIS PRODUCT IS NOT APPROVED FOR INSTALLING IN CERTIFIED AIRPLANES.

2.2 Main product functionalities

Basic list of main product functionalities:

- Automatic movement of the motor (flaps) to predefined positions
- user adjustable positions
- user-adjustable LBUS pin function (one of the following)
 - landing gear control output
 - input for dimming the display elements of the device
- Possibility to use Honeywell RTY series sensor as a position sensor (automatically detected by the device)
- Intelligent fault detection of position sensor, motor, undervoltage, high temperature and more
- indication of operating and fault states

2.3 Inputs

The flaps control unit has the following inputs:

- power supply inputs (dashboard electricity from the airplane)
- input for position sensor connection
- 2 inputs for optional limit switches
- dimmer signal input (shared with landing gear output control function)

2.4 Controls

The flaps control unit has the following controls:

- rotary switch with 3 to 4 positions (depending on type)
- 2 SET buttons

2.5 Outputs

The flaps control unit has the following outputs:







- motor power output
- output to landing gear control unit (shared with dimmer signal input function)

2.6 Indication

The flaps control unit has the following indication elements:

- 4x two-color LED (positions correspond to the rotary switch, by combining it is possible to achieve a total of 3 colors - orange, red, green)

The indication in this manual is represented by pictograms with the following meaning:

-  LED emits some color (orange, red, green)
-  LED is off
-  LED slowly (1x/s) flashes in some color (orange, red, green)
-  LED fast (5x/s) flashes in some color (orange, red, green)
-  LED slowly (1x/s) alternates two colors
-  LED quickly (5x/s) alternates two colors

2.7 Protections

The flaps control unit has the following protections:

- reverse polarity protection
- protection against overvoltage spikes of both polarities
- protection against interference and short circuit at the potentiometer input
- Undervoltage protection
- High temperature protection
- short circuit protection at motor output

2.8 Description of the control panel

2.8.1 Control panel HBR (4 control positions)

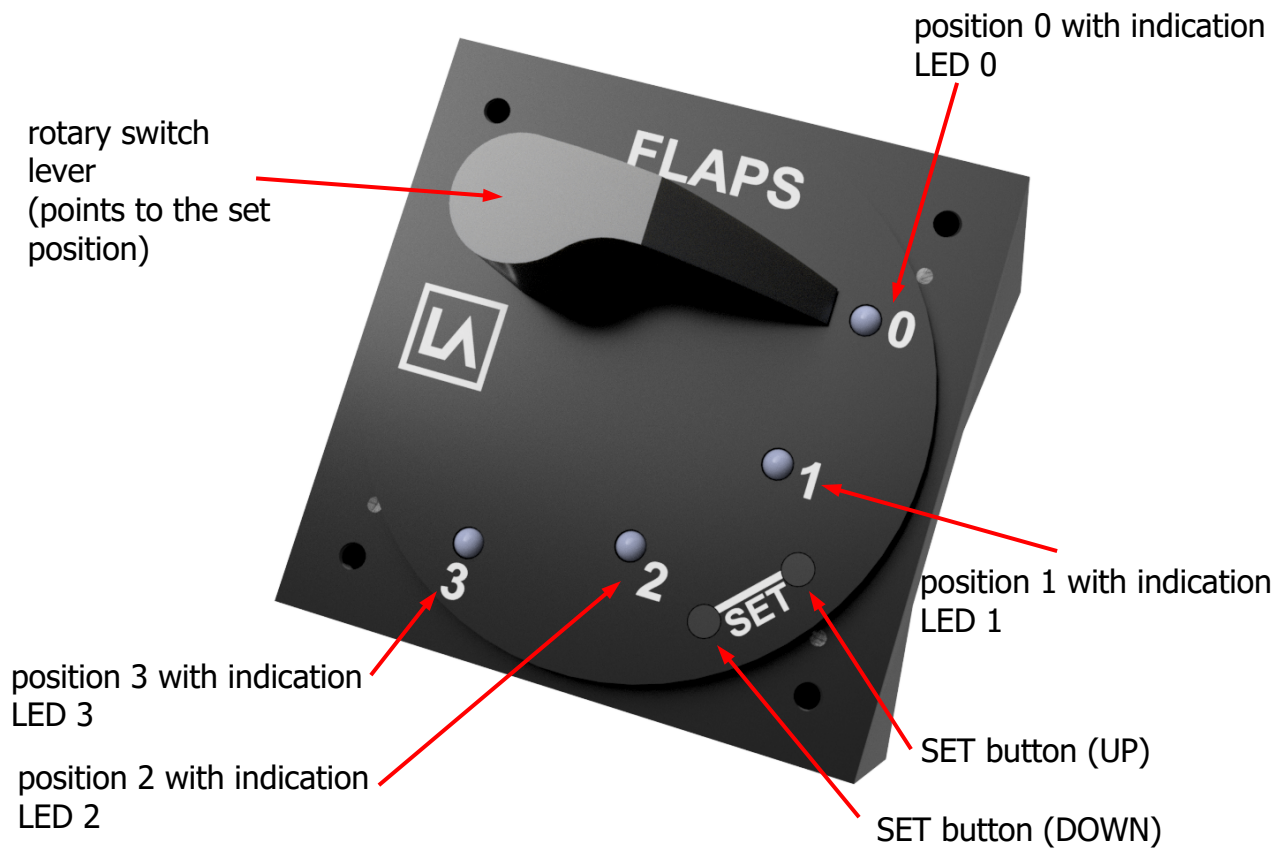

2.8.2 Control panel HBR 3P (3 control positions)

The panel has 4 indicator LEDs, as well as the basic HBR version, but the rotary switch lever can only be rotated between positions 0 to 2. The IND position is only an indicator LED.

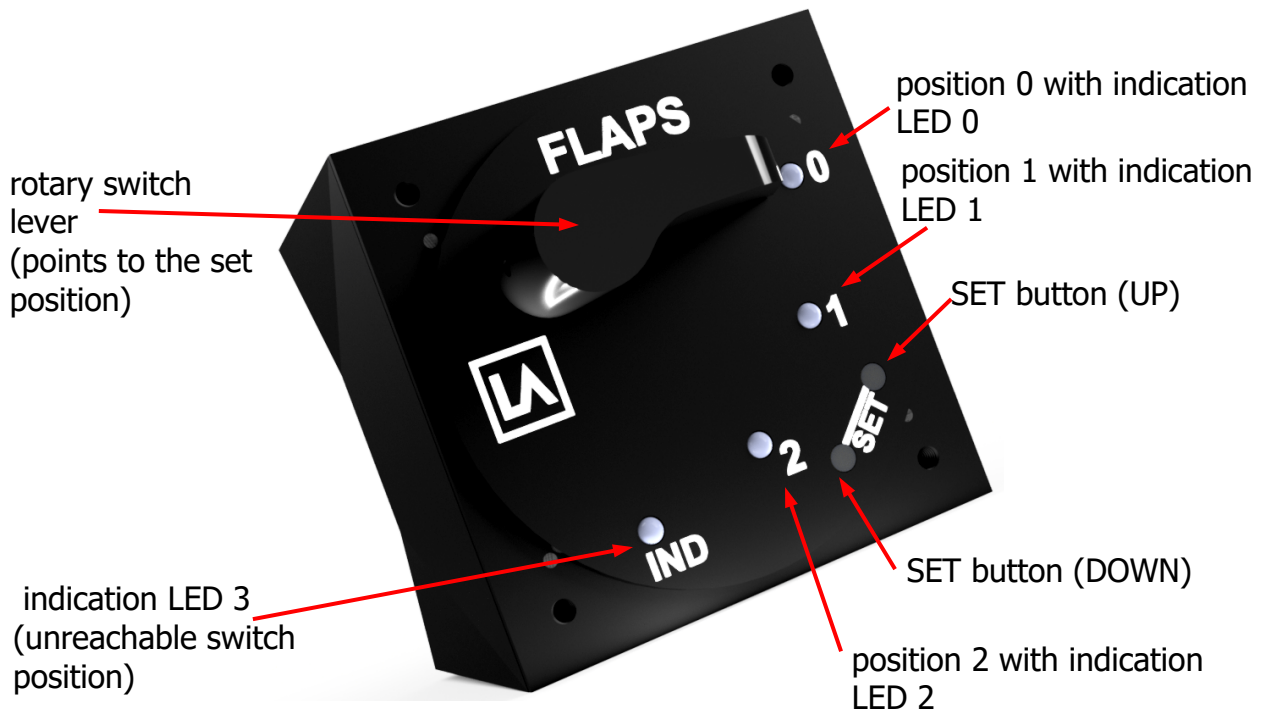

2.8.3 Control panel HBLC (4 control positions)

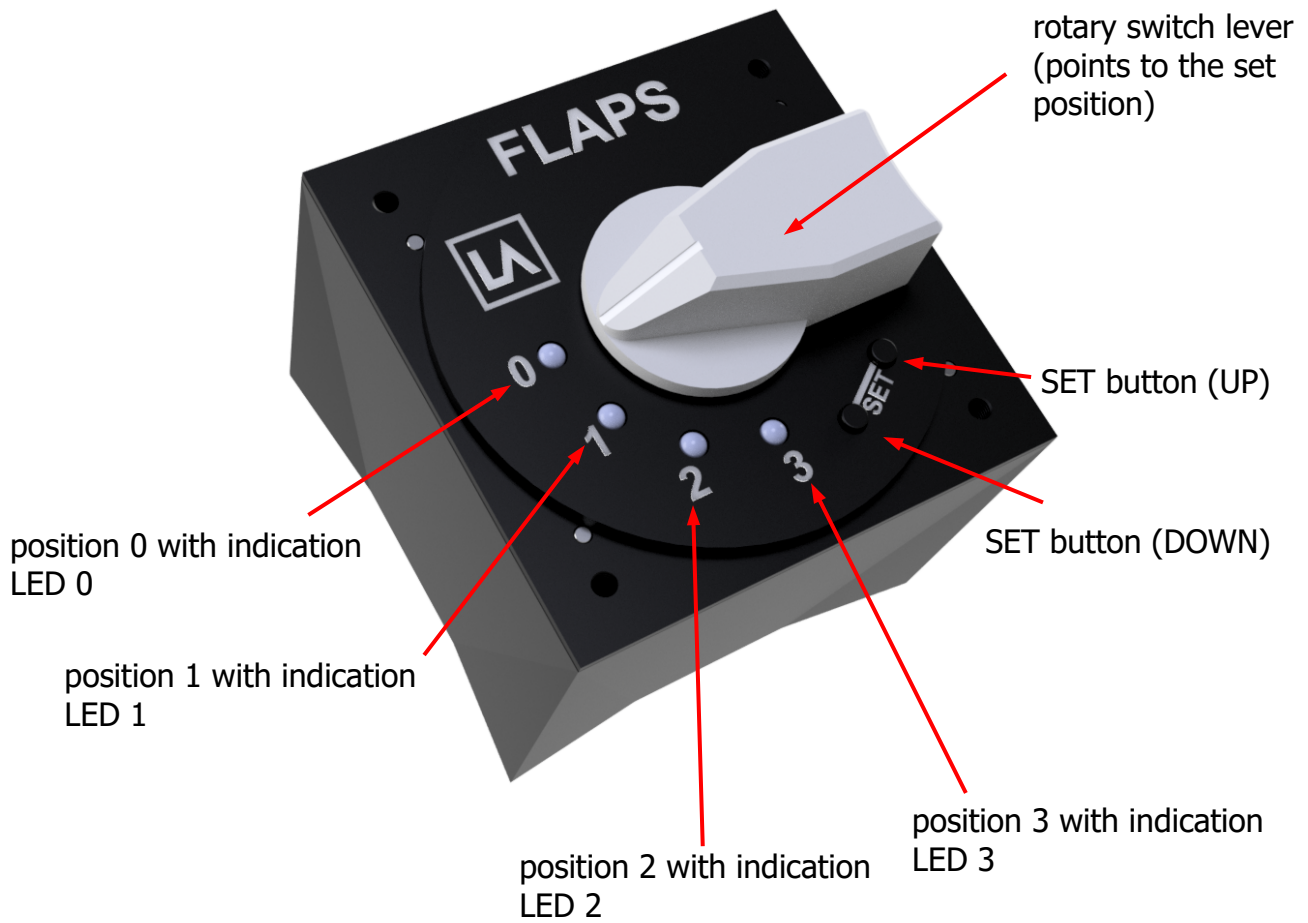

2.8.4 Control panel HBLC 3P (3 control positions)

The panel has 4 indicator LEDs, as well as the basic HBLC version, but the rotary switch lever can only be rotated between positions 0 to 2. The IND (or 3) position is only an indicator LED.

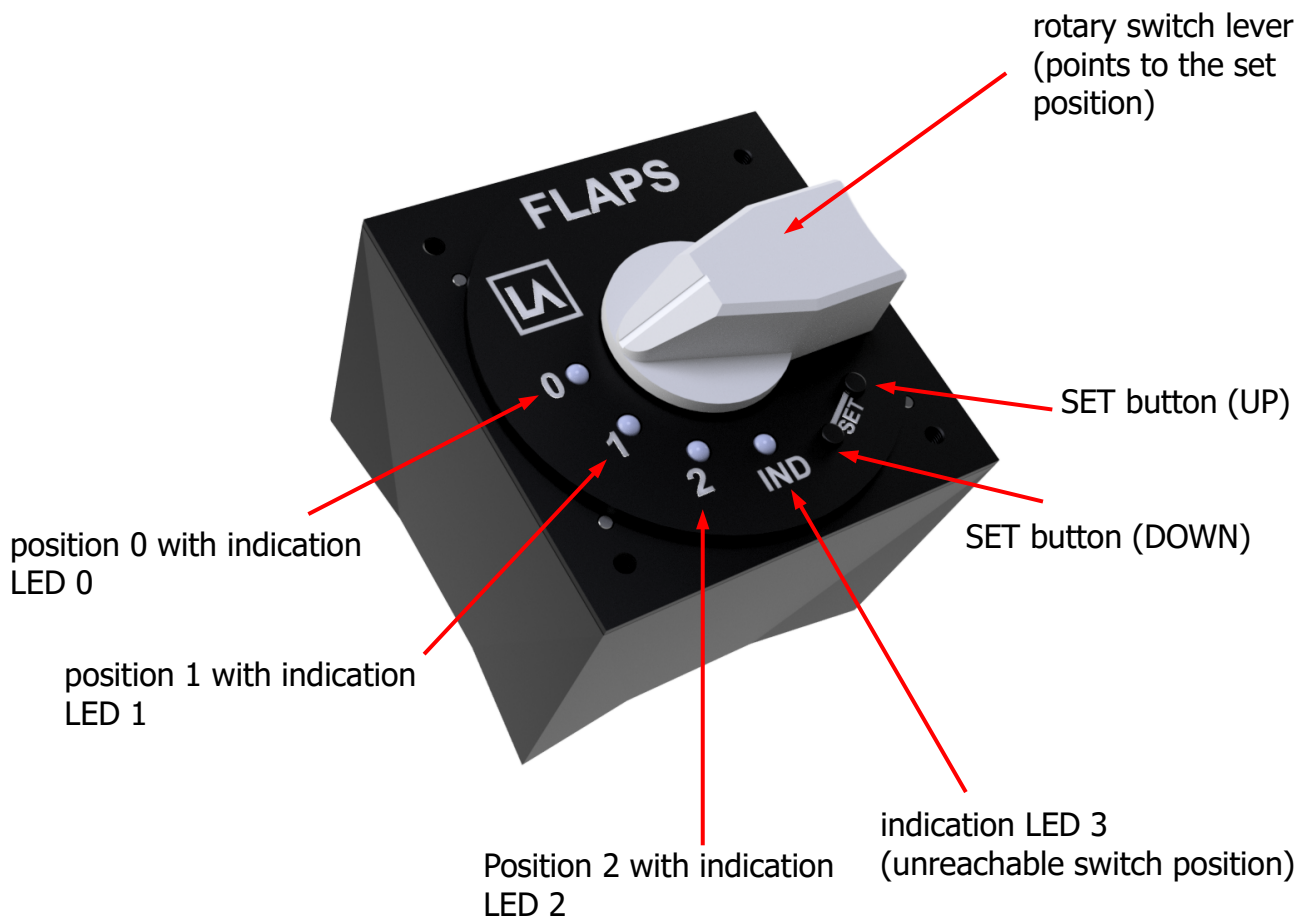

2.8.5 Differences between HBR, HBR 3P, HBLC, HBLC 3P variants and how to read this manual when using the HBR 3P variant

- The fault indication is the same for all manufactured device variants (i.e. the same as is for 4-position HBR variant which is used for pictograms, examples and description)
 - only the designation of the LED at position 3 could be changed to IND in 3-position (3P) variants, i.e. wherever the mention of LED 3 appears in this manual, this applies equally to IND, i.e. 3 = IND
- for HBLx (3P) variants - left-hand - positions and display elements are mirror-inverted against HBRx (3P) variants - numerical or letter designation of positions and their indications, to which descriptions of functions and indications refer, however, is unambiguous and also applies to left-hand variants
- in firmware (FW) version 2.01 of the control unit (indicated on the nameplate, current version as of the date of publication of this manual) the following exceptions from the functionalities for HBxx 3P (3-position variants) apply:
 - safety mode allows only the flaps to be raised to the 0° position due to the absence of position 3
 - passing beyond edge position 2 is not indicated by flashing LED 2
 - **it is not possible to perform mirror adjustment of the positions, ie position 0 must always be with the actuator piston retracted**

3 Specifications

3.1 Electrical characteristics

Parameter	Value	Unit	Notes
Power supply voltage V_{in}	11 ÷ 16	V	
Power consumption (typ)	0.5	W	@12V power supply, stand-by state without faults, actuator stopped at the selected position, without dimming
load(motor) current (max)	9	A	Higher current activates overcurrent protection
rated motor current	4.6	A	Linak LA12 type
the dimming voltage range at the DIMBOX accessory input	10 ÷ 16	V	PWM frequency 80 ÷ 200 Hz
Position sensor resistance	8 ÷ 12	k Ω	Resistive sensor type

NOTE The above specifications apply to the control unit or Linak LA12 actuator

3.2 Mechanical specifications

Parameter	Value	Unit	Notes
weight of control unit FLAPS V6 HBRxx	144	g	
weight of Linak LA12 actuator with 1m cable	833	g	
DIMBOX accessory weight	TBD	g	
dimensions of control unit FLAPS V6 HBRxx	60 x 60 x 65	mm	
dimensions of actuator Linak LA12	266 x 85 x 50	mm	Včetně upevňovacích ok, zatažená pístnice
Dimensions of DIMBOX accessory	42 x 12 x 16	mm	

3.3 Allowed operating conditions

Parameter	Value	Unit	Notes
Operating temperature	-30 ÷ +75	°C	
Operating humidity	10 ÷ 90	%RH	non-condensing
Operating atmospheric pressure	800 ÷ 1100	hPa	
IP protection	IP20	-	

NOTE The above specifications apply to the control unit.

3.4 Lifetime and warranty

The product is designed with regard to its intended use, for a long service life, higher than the intended service life (see below).

However manufacturer LAMBERT AERODEVICES s.r.o. HIGHLY RECOMMENDS to replace the product with a new one when it reaches its planned service life (any of the parameters below), or at the latest 10 years after purchase.

Parameter	Lifetime	Notes
Device flight hours	5000 h	
Motor engine hours	500 h	motor overload reduces service life to 20%
Rotary switch cycles	30000 turns	
Position sensor cycles	15000	passing the sensor path in one direction

Note: The above parameters are valid when the prescribed operating parameters (supply voltage, operating temperature, etc.) are observed. These parameters are recorded in the device and evaluated in the event of the warranty complaint.

The manufacturer grants a **24-month warranty** from the date of purchase. Exceeding any of the above durability parameters will void the warranty if this occurs before the warranty period has elapsed since the product was purchased.

The warranty also void in case of using the product in violation of this manual!

3.5 Tests according to DO-160G

THIS PRODUCT IS NOT APPROVED FOR INSTALLING IN CERTIFIED AIRPLANES.

The following tests according to DO-160G were performed on the control unit in an accredited testing laboratory, and met the criteria:

Name of the test	Chapter	Criterion	Notes
Temperature and altitude	4	B1	
Temperature Variation	5	B1	
Shock & Crash safety	7	A	
Vibration	8	R-B4	
Magnetic effect	15	A	
RF Sesceptibility	20	TT	
RF emission	21	B	

4 Installation in an airplane

Please pay special attention to the installation and wiring of all components of the flaps controller when installed in an airplane. This is important for the proper functioning of the equipment and the safety of the airplane.

4.1 Mechanical installation

The sketch below shows the dimensions needed to fit the FLAPS V6 HBxx control unit to the airplane dashboard.

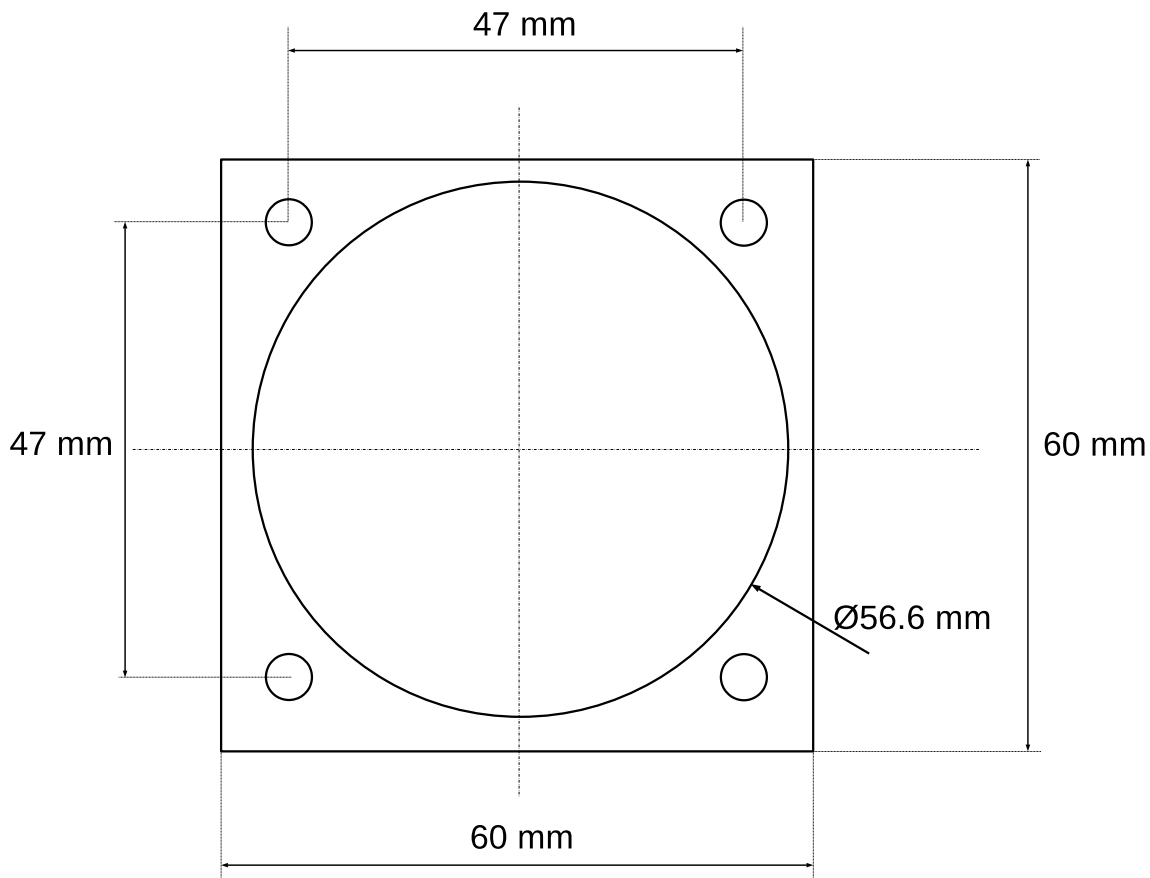

Mounting holes are provided with M3 thread and 4 mm thread depth.

4.2 Position sensor mounting

If an actuator without an integrated position sensor is used in the installation, it is necessary to use an external position sensor that is rigidly mechanically attached to the actuator rod so that the control unit has undistorted actuator position information.

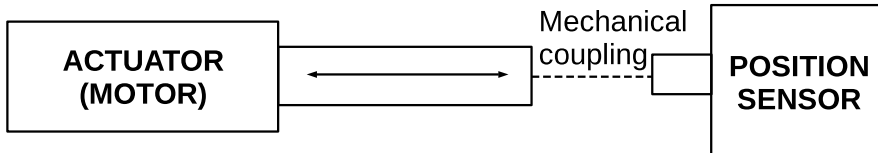

ATTENTION! The position sensor shall be mechanically coupled so that when the piston rod is fully extended or fully retracted, the position sensor is still within its valid travel range and remains at least 5% to its edge. (For example, the Honeywell RTY050 rotary sensor has a range from -25° to $+25^\circ$, so use the range from -22.5° to $+22.5^\circ$)

ATTENTION! Make sure that the position sensor is mounted correctly and that it is reliably secured against self-releasing.

4.3 Actuator installation

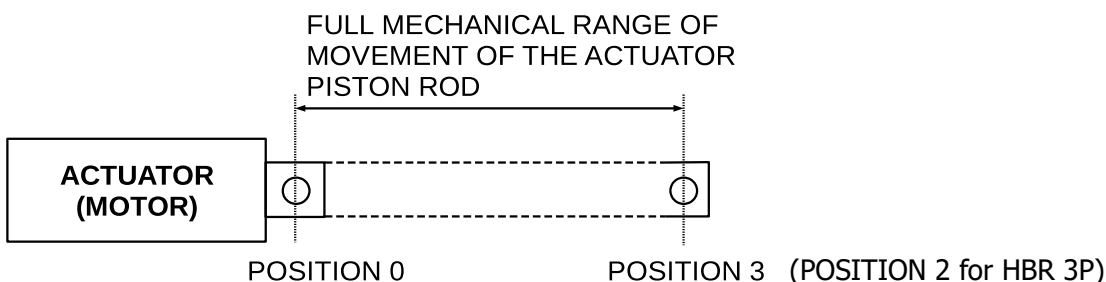

Observe the following points when installing the actuator:

- use the full mechanical travel range of the actuator piston rod to fully retract or extract the flaps, adjust the design of the flaps control elements so that the actuator (piston rod) is retracted as much as possible with the zero flaps (position 0), with full flaps (position 3, or position 2 for HBxx 3P with 3-positions) pulled out as far as possible
- verify the self-locking of the actuator in individual positions 0,1,2,(3) (all positions - according to the used control unit) with respect to the maximum design loading pressure on the flaps in flight; if the pressure exceeds the self-locking, use a higher self-locking actuator

ATTENTION! Failure to observe the above points may result in damage to the airplane / flaps in extreme situations

ATTENTION! If the actuator is not equipped with internal limit switches, it is **NECESSARY** to install these switches externally. More about this in the relevant section of chapter Electrical connections.

ATTENTION! If external limit switches are used in installation, it is necessary to ensure that they are reliably activated before the actuator piston rod hits one of its ends. Choose the location of the limit switches with sufficient margin.

ATTENTION! If external limit switches are used in installation, make sure that they are activated at the ends of the track, even if they are loosened slightly, by self-loosening of the screws, or other defects on switches or aircraft components.

4.4 Electrical connections

On the back of the device there is a 10-pin Molex Mini-Fit JR connector, which is used to connect the actuator, position sensor, limit switches, LBUS pin, power supply.

The figure below shows a view of the back and connector with numbered pins:

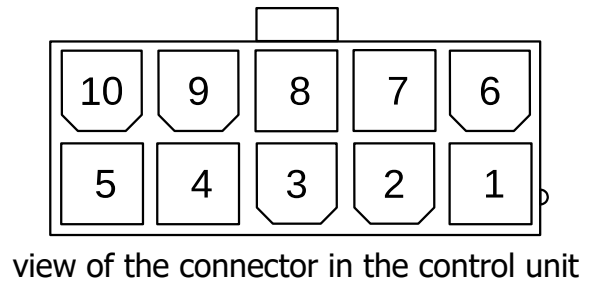
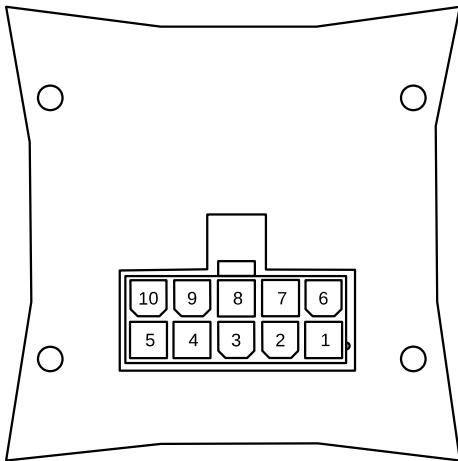

Pin no.	Signal name	Description	Notes
1	LIMSW_UP	Limit switch – against flaps rising	Opposite for inverse mechanical coupling
2	LIMSW_DOWN	Limit switch – against flaps lowering	Opposite for inverse mechanical coupling
3	POT_HI	Position sensor supply (+)	
4	POT_MID	Position sensor feedback signal	
5	POT_LOW	Position sensor supply (-)	
6	V _{IN} (+12V)	Power supply (positive)	
7	OUTB	Motor power output B	(+) for move flaps down
8	LBUS	LBUS signal	adjustable function
9	OUTA	Motor power output A	(+) for move flaps up
10	GND	Power supply (negative)	

ATTENTION! Use a suitably rated fuse in the power supply.

NOTE It is recommended to use shielded cabling, especially for motor conductors (to reduce radiated noise from the motor). Connect the shield to GND ONLY on the control unit side. NEVER at both ends!

4.4.1 Electrical connections of actuator with internal position sensor and limit switches

If the actuator you are using contains both a position sensor and limit switches, connect the control unit according to the following diagram.

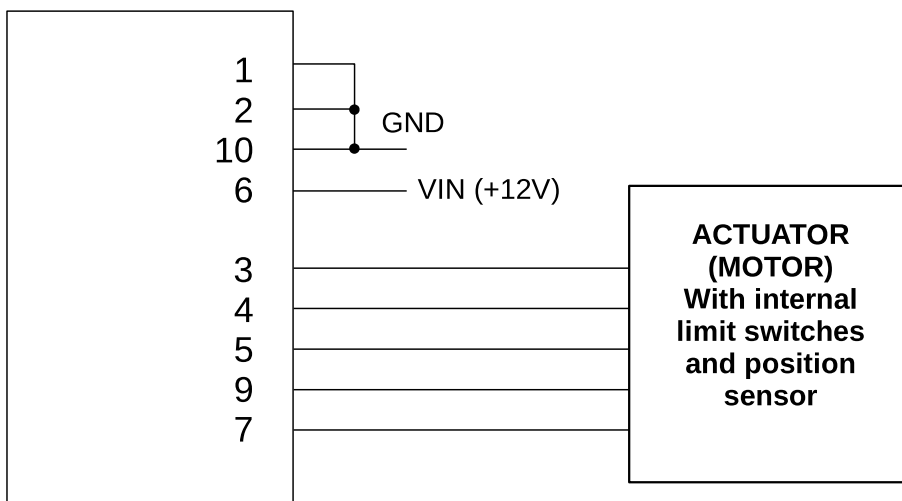

ATTENTION! Always refer to the documentation for the actuator used to identify the appropriate signals for the motor and position sensor. Then connect to the corresponding pins of the control unit connector, which are described in the table in chapter 4.4.

ATTENTION! If pins 1 & 2 are not connected to GND via external wiring, the control unit will NOT work properly !

ATTENTION! Always check with care that the actuator moves the flaps in the intended direction and not vice versa. If it moves the other way around, the motor wires are probably swapped. Then this test should be performed WITHOUT a connected position sensor, when the control unit enters Safety (manual) mode and therefore this test will not be affected by a potentially inverted position sensor (which is second option what could be wrong).

4.4.2 Electrical connections with simple actuator, external position sensor and limit switches

If your actuator does NOT include a position sensor or limit switches, it is NECESSARY TO CONNECT EXTERNAL ONES. Connect the control unit according to the following diagram, with an example of external limit switches and Honeywell RTY050 position sensor.

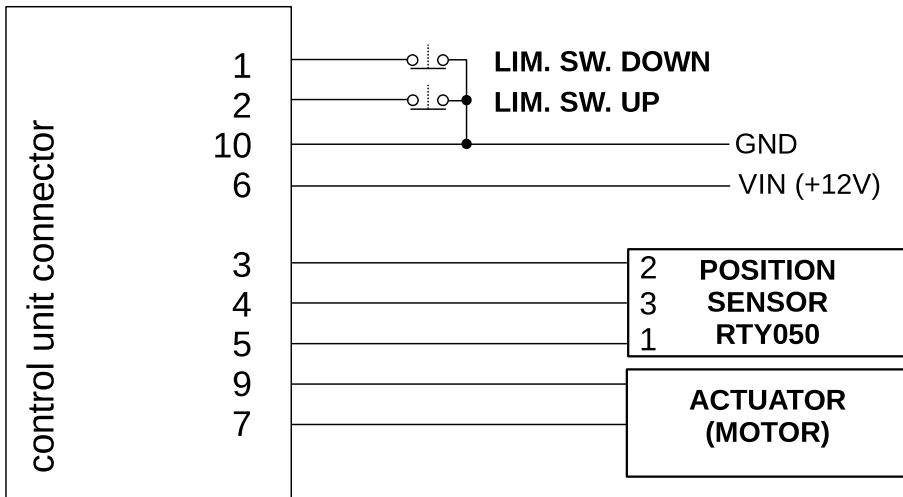

ATTENTION! Always check with care that the actuator moves the flaps in the intended direction and not vice versa. If it moves the other way around, the motor wires are probably swapped. This test should be performed WITHOUT a connected position sensor, when the control unit enters Safety (manual) mode and therefore this test will not be affected by a potentially inverted position sensor (which is second option what could be wrong).

ATTENTION! Always make sure that it stops the actuator for the direction to be protected before final mounting each of the limit switches. If it stops in the opposite direction, then reverse the electrical connection of the switches – i.e. swap pins 1 and 2 on the control unit connector.

ATTENTION! When using a digital electronic position sensor (such as the RTY050), make sure the polarity of the power supply is correct. Always read the sensor manual (different EU and US pinning). Follow the table in chap. 4.4 of this manual describing the pins on the control unit connector.

4.4.3 Electrical connections for dimming control unit display elements

ATTENTION! Never connect the dimmer directly to the control unit (without DIMBOX accessory) !!! The control unit may be irreversibly damaged! The unit can be directly connected without a dimbox to the 1st channel of the 12-channel MULTIDIMMER (see product manual) offered by the manufacturer LAMBERT AERODEVICES s.r.o..

The figure below shows the wiring diagram for dimming of the indicator elements. It shows how to connect the dimmer via DIMBOX (accessory to the FLAPS V6 control unit).

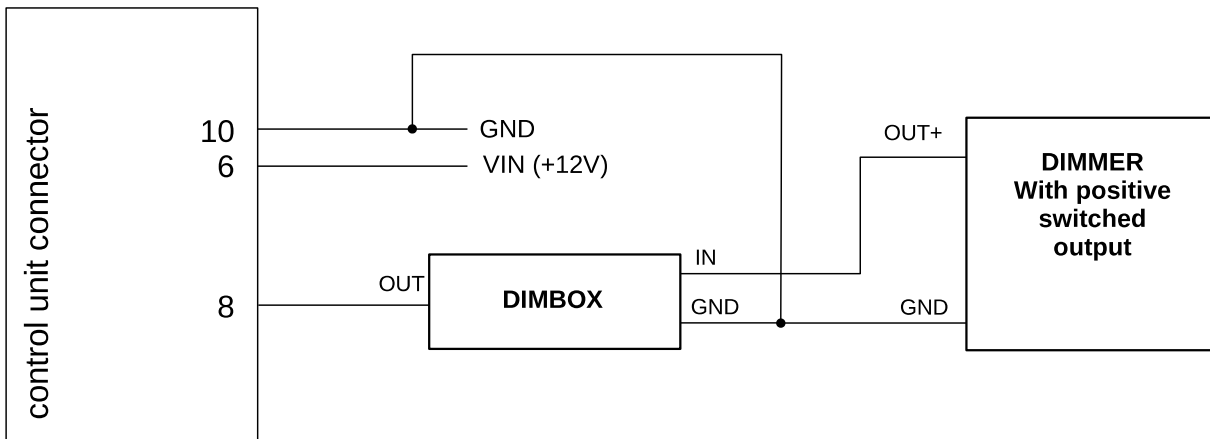

ATTENTION! For simplicity, the diagram does not include other important elements and connections mentioned in the previous chapters! Only those that are necessary to explain the wiring for dimming the indicator elements.

ATTENTION! To use the indicator dimming function, you must configure the control unit as described in chapter 5.5 Device Setup Mode.

DIMBOX accessory has fixed wires marked with labels, more info in the table below:

Wire label	Signal function desc.	Notes
OUT	DIMBOX output	to LBUS input of control unit FLAPS V6
IN	Positive input for dimmer signal - PWM 10 ÷ 16 V, 80 ÷ 200 Hz	Dimmer with positive output PWM switching connected to the same potential as the control unit and DIMBOX
GND	Negative power supply (-)	Connected to the same GND potential as the control unit





5 Description of functions

5.1 Normal mode – automatic

- as soon as the power is switched on, the control unit performs the initialization sequence, which is indicated by the successive lighting of all LEDs first in red, then gradually by changing the color of each LED from red to green; at the end of the initialization sequence all LEDs turn off
 - this initialization sequence allows to verify that all LEDs of the device are working, each red and green color (orange is created by mixing both)
- after the initialization sequence the device waits for a command regardless of whether the flaps are in the position corresponding to the switch or not
 - the actual real position of the flaps is indicated by the corresponding position LED (for more information see the position indication table later in this chapter)
- by turning the rotary switch to one of the positions 0,1,2, (3) (corresponding to the positions of the flaps 0°, 10°, 20°, 30°; possibly another scaling according to the user settings and the used variant HBxx or HBxx 3P, which have only position 0-2) the unit starts the automatic adjustment of the flaps by means of the electric actuator to the desired position
- the progress of the adjustment is indicated by the orange LEDs of the individual flaps positions, which are currently passed through until the stop at the given position indicated by the green color of the LED corresponding to the given position

Flap position indication table:

Indication	Meaning	Notes
 lights	the flaps are in the range of the position of the respective LED (stopped or in motion)	
 lights	the flaps are located exactly at the position selected by the switch and are stationary	
 flashes 1x/s (slowly)	the flaps are located behind the position of the respective LED (out of the range of positions set by positions 0,1,2,(3)) and stand still	indicated at end positions 0 and 3 (2 for HBxx 3P)

5.2 Errors and faults

The device is able to detect various types of errors and faults. These errors and faults are indicated by LEDs and in most cases functionality of the normal (automatic) mode is blocked.

In particular, the following faults are an exception:

- **Fault Motor overcurrent**
 - when the rotary switch is turned, the fault is cleared and the device waits for the next command
 - if this fault continues to occur, it is likely that the engine, wiring, or airplane mechanics are defective; turn the device off and do not use it
 - power reset also clears this error
- **Position sensor malfunction**
 - after indication of this fault and then turning the rotary switch to one of the positions 1 or 2, the safety (manual) mode will be activated, which is described in more detail in the relevant chapter of this manual
 - if this error is corrected / fade away, error indication is automatically erased and the device returns to normal (automatic) mode
- **Move to position timeout error**
 - after turning the rotary switch, the fault is cleared and the device automatically returns to normal (automatic) mode and immediately starts to move the flaps to the position corresponding to the current setting of the rotary switch
 - power reset also clears this error

Other faults, with some exceptions, remain valid until their cause has subsided.

A detailed list of errors and faults, their causes, indications, remedies, etc., is found in the last chapter of this document.

ATTENTION! If the device is permanently in a malfunction which cannot be corrected, turn off the device and do not use it. Then check the mechanical installation, wiring, etc.

5.3 Safety mode – manual

When the Position Sensor Fault indication is displayed and then the rotary switch is turned to either position 1 or 2, it switches to Safety (manual) mode, which is described in more detail in this section.

Safety mode is indicated by steady red LEDs 1 and 2 and flashing green LEDs 0 and 3 (see following figure)

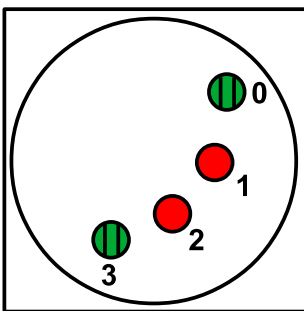

The manual actuation of the flaps actuator then takes place using one of the following selections using the rotary switch:

- **Position 0:** Actuator moves the flaps towards 0°
- **Positions 1 and 2:** the actuator stops and stops
- **Position 3:** Actuator moves the flaps towards 30°

ATTENTION! It is necessary for the operator to visually check the movement and position of the flaps for the whole time of their adjustment in safety (manual) mode! ALWAYS turn the rotary switch to position 1 or 2 when the desired flaps position is reached, where the actuator stops and remains stationary.

5.4 Device setup mode

This mode is used for service setting of device functions and parameters. **The device allows you to set the following parameters and functions:**

- Functionality of the LBUS pin (landing gear control output / dimmer input)

The following sequence of actions is **required to enter the mode:**

- 1) device in off state (power off)
- 2) Press and hold both SET buttons
- 3) turn on the power to the device
- 4) wait a few seconds for the initialization sequence to complete and then all the LEDs turn orange or red
- 5) Release the SET buttons

After entering Device setup mode, the controls and indicators have the following functions:

- rotary switch = selection of the function / parameter to be edited given by the position of the switch lever
- SET buttons = increase or decrease the set parameter setting (parametric option)
- LEDs = numeric indication of the set value (parametric option) of the parameter selection (in binary code, where orange is 0 and red is 1)

Overview table of possible settings:

Function / Parameter Name	Parametric Option	Function/Value
LBUS pin functionality (switch position 0)	0*	Landing gear control output
	1	Input for dimming indicator elements
	2	<i>RESERVE, for future use</i>
	3*	<i>RESERVE, for future use</i>

* factory preset value

** cannot be selected with the rotary switch for the HBxx 3P variant

Indicative table of binary states (values 0 to 3, other possible values analogously):

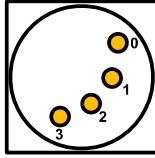
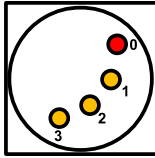
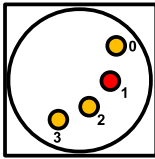
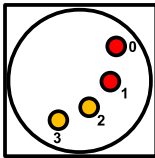
(Decimal) Value of the Parametric Option	Binary Value of the Parametric Option	Visualization of the colors of the indicator LEDs for a given Parametric Option
0	0000	
1	0001	
2	0010	
3	0011	

To save the settings and exit the setup mode, you MUST perform the following sequence of actions:

- 1) quickly press and hold both SET buttons
 - all LEDs start flash alternately orange and green and all go off within approx. 2 seconds - this indicates successful saving of all settings
- 2) After releasing the SET button, the device goes into normal mode (steady state)

ATTENTION! If the supply voltage is lost during the Device setup mode, the changes are not saved! and the next time the device is turned on, it will run at its original settings.

ATTENTION! Avoid losing power while saving settings (alternating blinking of orange / green LEDs - this could result in incorrect data storage or even damage the device)

5.5 Position programming mode

This mode is used to precisely set (or fine-tune pre-programmed) positions to which the actuator or the flaps connected to it are adjusted (extended and retracted).

The control unit has factory preset target positions, with target position 0 corresponding to the fully retracted actuator.

NOTE: Position of each target position (0,1,2, optionally 3 for the 4-positional HBxx variants) is programmed INDIVIDUALLY.

ATTENTION! All malfunctions cancel or prevent the Position programming mode, **except** for the Programmed Positions Error, which disappears only after all positions have been programmed correctly (and therefore it must not block Position programming mode) .

To program one particular position, the following procedure must be performed:

- **Set the rotary switch** to the position intended for programming
- **Press and hold both SET buttons** until the LED of the corresponding programmed position flashes orange quickly (flashing at approx. 5x/s)
- **release SET buttons** (programming mode is now active)
- **Press one of the SET buttons** to move the actuator rod to the desired position
 - the piston rod is only moved when the button is pressed, the actuator stops when the button is released
 - **If You are programming the position on the very limit of mechanical range** of piston rod (i.e. at one of the stops with limit switch activated), **DO NOT release the SET button** used to reach this position, but hold in until position correspondin LED starts quickly alternating orange/green colors (5x/s). This comes approximately 3 seconds after actuator reaches limit switch and stops movement.
 - This acts as a confirmation given to the control unit that reaching limit switch is being intended
 - If You do not follow this, automatic control adjustment may not reach fully the intended position (while limit switch activated)
- **release SET button**

- **Quickly press and HOLD both SET buttons**
 - The corresponding LED changes the flashing to slow alternation of colors orange and green, both colors alternate approx. 1x/s (signalizing running of calculations and storing the data into device's memory)
 - approx after 2 seconds LED turns off
- **After LED turns off, release SET buttons** (exits Position programming mode)

Repeat this sequence described above for all positions you want to program or tune.

IMPORTANT NOTE: If you are reprogramming the sequence of target positions mirrored to the factory preset target positions (newly position 0 corresponds to the actuator retracted), Programmed Position Error will be displayed as soon as the first edited target position is stored on the opposite end of the piston rod path. This is NOT a problem! The control unit checks that the positions of the individual target positions are consecutive. Proceed further by programming NEXT target positions. After reprogramming the last of the target positions, the Programmed Position Errors disappear (of course if the target positions are consecutive and do not overlap).

ATTENTION! The positions of the target positions must not be thrown over or overlap (distance > 2mm movement of the piston rod). The device checks this condition and reports Programmed Position Error if it is not observed. Compliance with this condition is essential for proper operation of the device.

ATTENTION! If the supply voltage is lost during the Position Programming Mode, changes to the currently programmed target position are not saved! and the next time the device is turned on, it will run at its original settings.

ATTENTION! Avoid losing power while saving settings (alternating blinking of corresponding orange / green LED - data could be stored incorrectly or even damaged)

5.6 Landing gear control output

If the LBUS pin function is set as the landing gear control output (factory default), then the output behavior is as follows, depending on the rotary switch setting:

- Turning the rotary switch to position 2 or 3 activates the LBUS output
- Turning the rotary switch to 0 or 1 disables the LBUS output

ATTENTION! The landing gear control output is intended solely for connection to the corresponding input of landing gear control unit manufactured by LAMBERT AERODEVICES s.r.o.

5.7 Dimming of indicator elements

Dimming of indicator elements is possible only if the following conditions are met:

- DIMBOX accessory is connected to the FLAPS V6 control unit
- the control unit has been configured to dim by the LBUS pin
- the DIMBOX accessory input is connected to a dimmer output that is at a common potential as DIMBOX and FLAPS and outputs positive PWM pulses of the appropriate voltage level and frequency

When the dimmer is turned off, set to minimum or disconnected, the unit maintains internally set minimum functional intensity of the indicator elements – i.e. the indicator elements never turn off completely.

ATTENTION! NEVER connect a dimmer directly to the FLAPS control unit! Always via DIMBOX accessory. Direct connection may result in damage to the FLAPS unit.

6 Errors and faults, troubleshooting

6.1 Indicated errors and faults

The FLAPS V6 HBxx control unit can indicate up to 4 types of serious faults. The table below lists these faults, their indications, and a more detailed description. Individual errors are indicated by orange blinking of the LED and the other LEDs are red.

Blinking can be **slow (1x/s)**  or **fast (5x/s)** .

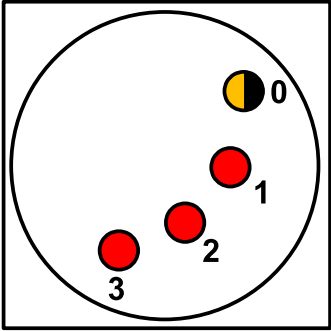
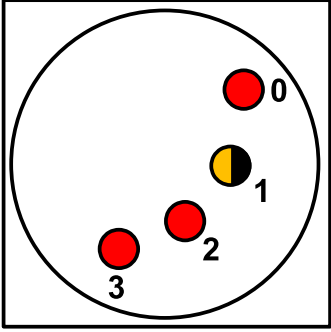
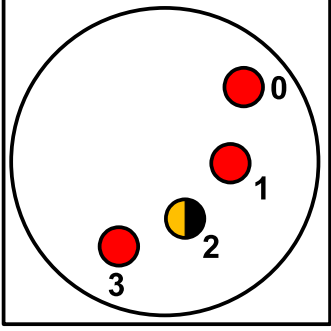
Indication	Fault name	Description & Cause	Solution
	Programmed Positions Error	The programmed positions of the target positions are shuffled or overlapped. It often occurs when reprogramming target positions mirrored against factory preset.	Reprogram all target positions one after the other so that the positions of the target positions go gradually and do not overlap (i.e. positions on the piston rod distance <2mm)
	Position Sensor Fault	Poor connection, short circuit, or disconnection of the position sensor circuit. This may be due to a fault in the wiring or the position sensor, in rare cases in the control unit.	In flight, turn the switch to position 1 or 2 to activate the Safety Manual mode (see Chapter 5.3). On the ground, check the wiring and functionality of the position sensor.
	Error Low Voltage	Weak battery or long leads to FLAPS V6 unit with too high voltage drop at high actuator load	Check the current-carry dimensioning of the on-board power network, battery condition, shorten the leads to the FLAPS V6 unit, the leads to the actuator (if necessary, increase the cross-sections of the wires if the leads cannot be shortened)

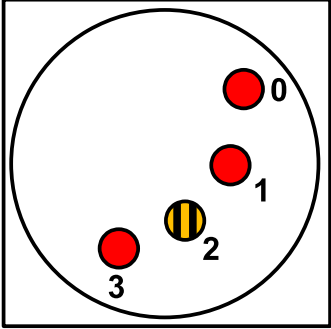
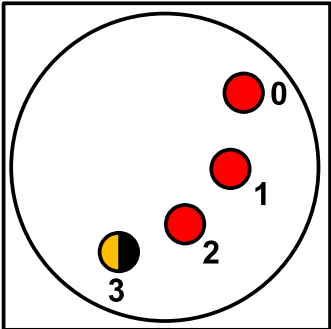
Indication	Fault name	Description & Cause	Solution
	Error Undervoltage	Low battery or wiring fault	Check the wiring, the current-carry dimensioning of the on-board power network, battery condition, shorten the connections to the FLAPS V6 unit, the connections to the actuator (if necessary, increase the wire cross-sections if the leads cannot be shortened)
	Motor Overcurrent Error	The actuator current has exceeded the limit value. Possible causes: The actuator was extremely overloaded, short-circuit on the actuator wires, actuator failure, etc.	When the switch is turned, the fault is reset. If this occurs repeatedly, do not use the device until you have checked the installation, wiring, actuator, and mechanical construction that can cause extreme actuator overload.

In some circumstances, the above-mentioned failures can occur in combination of several at the same time. Then the indication is such that 2 (or more) LEDs of the respective faults flash orange and the other LEDs are red.

Example of a combination of faults **Programmed position error** and **Position sensor fault**:

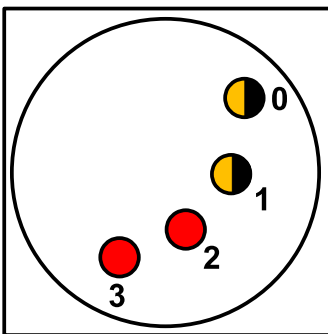

In addition, the FLAPS V6 HBxx indicates several non-critical errors that may occur in operation under certain circumstances by blinking or illuminating the LED combination:

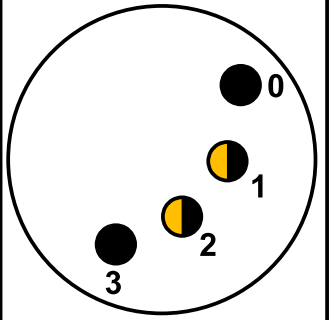
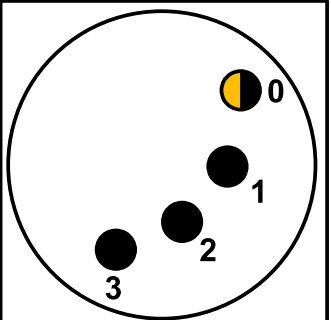
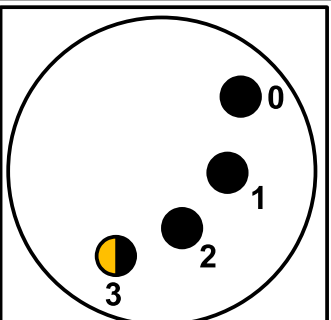
Indication	Fault name	Description & Cause	Solution
	<p>Move to position timeout error</p>	<p>The flaps actuator did not reach the programmed position. 2 LEDs with orange light (blinking) indicate between which positions the actuator has stopped. This may be due to the airplane's low battery, long leads, flaps overload, etc.</p>	<p>Check the current-carry dimensioning of the on-board power network, the battery condition, shorten the leads to the FLAPS V6 unit, the leads to the actuator (possibly increase the cross-sections if the leads cannot be shortened). Turning the switch again will reset the error and activate the actuator movement.</p>
	<p>Error Actuator position above highest position</p>	<p>The actuator is in a position that is higher than the highest programmed target position 0. This can be caused by exceeding the self-locking force of the actuator and mechanical shifting, eventually electric travel e.g. in Position Programming Mode (not saved) followed by device reset</p>	<p>The control unit allows the actuator to move without restriction in the inward direction to the position range. Simply select one of the flaps target positions by turning the rotary switch and the control unit activates the actuator adjustment to the specified position.</p>
	<p>Error Actuator position below lowest position</p>	<p>The actuator is in a position that is lower than the lowest programmed target position 3. This can be caused by exceeding the self-locking force of the actuator and mechanical shifting, eventually electric travel e.g. in Position Programming Mode (not saved) followed by device reset</p>	<p>The control unit allows the actuator to move without restriction in the inward direction to the position range. Simply select one of the flaps target positions by turning the rotary switch and the control unit activates the actuator adjustment to the specified position.</p>

ATTENTION! Programmed Position Error may in rare cases be indicated in combination with Position Sensor Fault even if the target positions are programmed correctly. This is due to the principle of operation of the SW control and the interplay of random combinations of external influences and the Failure of the Position Sensor. The programmed position error also disappears when the Position Sensor fault is cleared. It is therefore NOT necessary to reprogram the positions of the individual positions.

6.2 Troubleshooting

The most common faults and their elimination are dealt with in **Chapter 6.1 Indicated errors and faults**, where the causes and possible remedies of the indicated errors and faults are listed in the table.

However, if you do not find a solution to your fault in the that chapter, try to find the solution in the following table:

Fault description	Possible causes	Solutions
The actuator does not reach the limit switch	<ul style="list-style-type: none"> • Unwanted mechanical shift of the external limit switch • Poor programming of the position – not Acknowledged travel to the limit switch 	<ul style="list-style-type: none"> • Check the mechanical attachment of the limit switch • reprogram (according to the relevant chapter of this manual) the target position with the limit switch

NOTE This chapter is gradually supplemented based on product experience and customer inquiries.

Document change table:

Rev.	Date	Author	Description
0	24.3.2020	ATAMAN	Initial version
1	20.5.2020	ATAMAN	Added information about 3-position variant HBR 3P, added info about tests
2	8.7.2020	ATAMAN	Added information about HBLC variants, device mentioned as HBxx in texts to take more variants in account
3	19.08.2022	NEPOR	LA, graphical correction
4	11.10.2022	NEPOR	HBLC 3P picture
5	20.02.2023	NEPOR	HBLC and HBLC 3P picture
6	26.05.2023	NEPOR	Move to position timeout error correction, graphical correction, multidimmer



www.lambert-aerodevices.cz